

4ch. Read/Write Amplifier for Thin Film Head of Hard Disk Drive

Description

The CXA3510N is a Read/Write Amplifier for the thin film head of hard disk drive and designed to handle up to 4 channel heads.

Features

- Operate on single +5 V power supply
- Low power consumption
 - Read : 85 mW
 - Write : 115 mW + $I_w \times 5$
 - Idle : 8 mW
- Designed for two terminal thin-film or MIG heads
- Read amplifier emitter follower output featuring 360 times gain (typ).
- Differential input capacitance for Read : 6pF (typ)
- Input noise : $0.47 \text{ nV} / \sqrt{\text{Hz}}$ (typ)
- Write current range : 5 to 15 mA
- Differential Head voltage swing : 9 Vp-p (typ)
- I_w Rise / Fall times : 3.7 ns (typ)
($L_H=540 \text{ nH}$, $R_H=25 \Omega$, $I_w=10 \text{ mA}$)
- Differential P-ECL write data input
- Built-in write unsafe detection circuit.
- Built-in Servo write function (2/4 ch).
- Built-in IC protection circuit for short of head to GND.
- Read data outputs are high impedance in write mode.
- Unselected head voltage is GND potential.
- Built-in supply voltage monitor circuit prohibits incorrect write during power on or abnormal voltage.
- Self switching damping resistance ($R_D = 360 \Omega$).

Function

Read, Write and Write unsafe detection for HDD,
power supply ON/OFF detection.

Structure

Bipolar silicon monolithic IC

20 pin SSOP (Plastic)

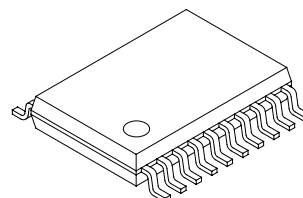

Absolute Maximum Ratings (Ta=25 °C)

• Supply voltage	V_{CC}	6	V
• Write current	I_w	20	mAo-p
• Operating temperature	T_{opr}	-20 to +75	°C
• Storage temperature	T_{stg}	-55 to +150	°C
• Allowable power dissipation	P_D	620	mW
• WUS/SE pin input current	I_{SEH}	15	mA

Recommended Operating Conditions

• Supply voltage	V_{CC}	5.0 V±10	%
• Write current	I_w	5 to 15	mAo-p

Block Diagram and Pin Configuration

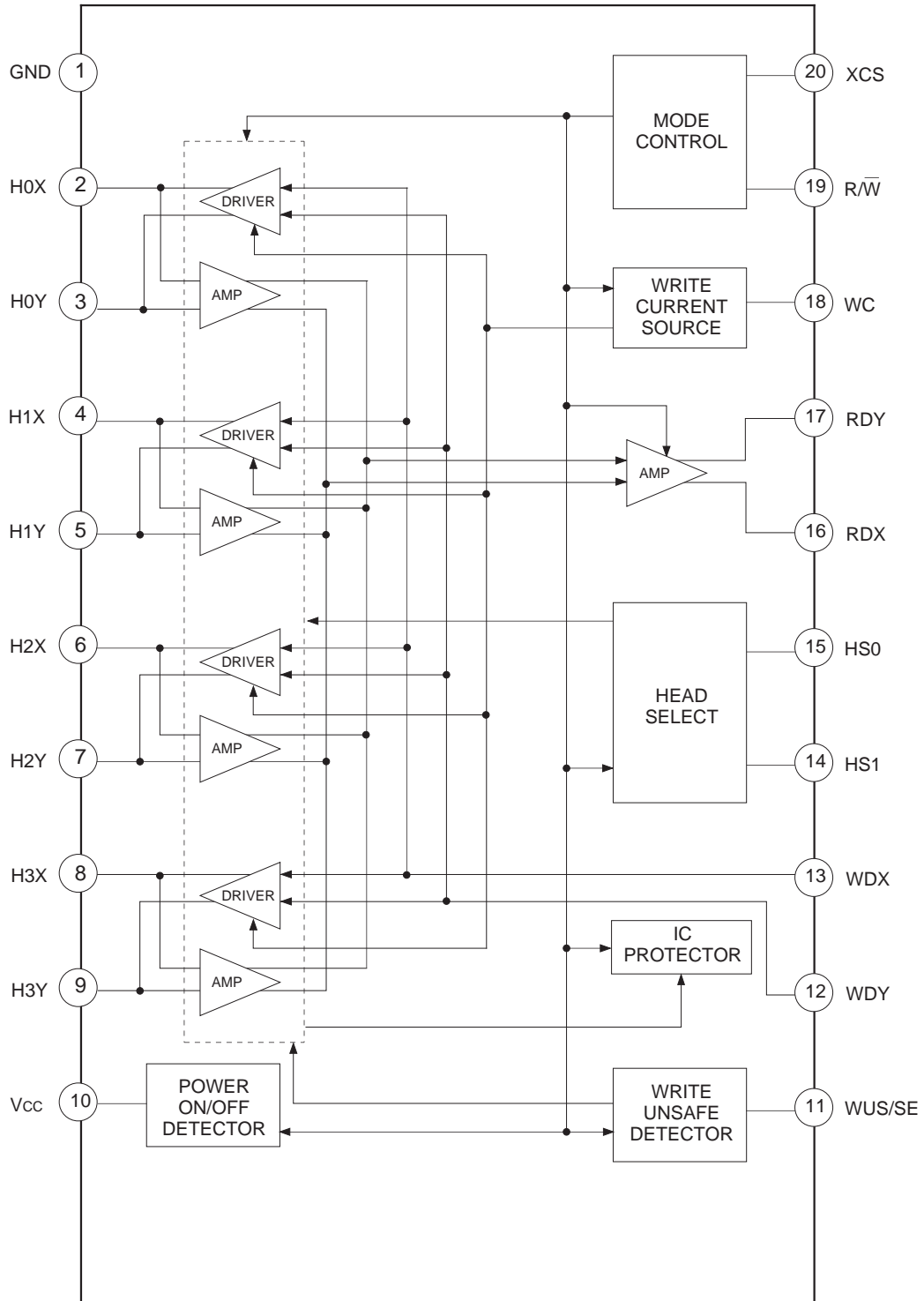

Pin Description

No.	Symbol	Equivalent circuit	Description
1	GND		
2 3 4 5 6 7 8 9	H0X H0Y H1X H1Y H2X H2Y H3X H3Y		Head. 4 channels provided.
10	Vcc		5 V power supply.
11	WUS/SE		Write unsafe detection output / Servo Enable signal input.
12 13	WDY WDX		Differential P-ECL write data input.

No.	Symbol	Equivalent circuit	Description
14 15	HS1 HS0		Head select signal input. Selects one of 4 heads according to Table 2.
16 17	RDX RDY		Read Amplifier output.
18	WC		A setting resistor for the write current value is connected between this pin and GND.
19	R/W		Read/Write signal input At "High" : Read, at "Low" : Write.
20	XCS		Power save signal input At "High" : Power saving.

Electrical Characteristics (Unless otherwise specified, V_{cc}=5 V, T_a=25 °C, Write current I_w=15 mA)
Refer to Fig.1

No.	Item	Symbol	SW conditions														Measurement conditions	Min.	Typ.	Max.	Unit	
			1	2	3	4	5	6	7	8	9	10	11	12	13	14						
1-1	Current consumption for Read	I _{CCR}	a	a	a	a	b	a	a	a	a	a	b	a	a	Test point : I ₂	11	17	26	mA		
1-2	Current consumption for Write	I _{CCW}	a	a	a	a	b	a	a	a	a	b	a	a	a	Test point : I ₂	16 +I _w	22 +I _w	36 +I _w	mA		
1-3	Current consumption for idle	I _{CCI}	a	a	a	a	b	a	a	a	a	b	a	b	a	Test point : I ₂	1.0	1.6	2.3	mA		
2-1	Digital input "Low" input voltage	V _{IL}														Digital input : Pins 14, 15, 19, 20			0.8	V		
2-2	Digital input "High" input voltage	V _{IH}															2.0				V	
2-3	Digital input "Low" input current	I _{IL}	a	a	a	a	b	a	a	a	a	b	a	a	a	"High" applied voltage : 5 V "Low" applied voltage : 0 V	-100				μA	
2-4	Digital input "High" input current	I _{IH}	a	a	a	a	b	a	a	b	b	b	b	b	b	Test point : I ₆ , I ₇ , I ₈ , I ₉			100		μA	
2-5	Write data input "Low" input voltage	V _{WDL}															V _{WDH} -2.0			V _{WDH} -0.25	V	
2-6	Write data input "High" input voltage	V _{WDH}															V _{CC} -1.1			V _{CC} -0.4	V	
2-7	Write data input current	I _{WD}	a	a	a	a	b	a	a	a	b	a	a	a	a	Input voltage : 4 V			50		μA	
2-8	Unselected head voltage	V _{Unsel}																		0.3		V
3-1	Write unsafe output saturation voltage	V _{WUS}	b	a	a	b	a	c	c	c	c	b	a	a	a	Output current : 1 mA Test point : V ₁				0.5		V
3-2	Write unsafe output leak current	I _{WUS}	a	a	a	a	a	a	a	a	b	a	a	a	a	Test point : I ₃				50		μA

No.	Item	Symbol	SW conditions														Measurement conditions	Min.	Typ.	Max.	Unit
			1	2	3	4	5	6	7	8	9	10	11	12	13	14					
4	Supply power ON/OFF detector threshold voltage	V_{TH}	b	a	a	a	a	a	a	a	b	a	a	b	a	a	3.4	3.9	4.3	V	
5-1	Write current setting range	I_w															5		15	mA _{o-p}	
5-2	Write current voltage	V_{wc}	a	a	a	a	a	b	a	a	b	a	a	b	a	a	2.25	2.5	2.75	V	
5-3	Write current gain	A_w															18	20	22	mA/mA	
5-4	Write current setting constant	K_w	b	a	a	a	a	b	a	a	b	a	a	b	a	a	45	50	55		
6-1	WUS/SE voltage	V_{SEH}															$V_{cc} + 1.5$		$V_{cc} + 1.6$	V	
6-2	WUS/SE sink current	I_{SEH}	b	a	a	a	a	b	a	b	a	a	b	a	a	a	5		14	mA	
7	Read amplifier differential voltage gain	A_v	b	a	a	a	c	b	a	a	b	a	a	b	b	a	305	360	415	V/V	
8	Frequency band width (-3 dB)	BW	b	a	a	a	c	b	a	a	b	a	a	b	b	a	100	140		MHz	

No.	Item	Symbol	SW conditions														Measurement conditions	Min.	Typ.	Max.	Unit
			1	2	3	4	5	6	7	8	9	10	11	12	13	14					
9	Input referred noise	E_N	a	a	a	a	a	a	a	a	a	a	a	a	a	a	a	Head impedance : 0 Ω , when the read amplifier output voltage is amplified 100 times and voltage passed through a LPF (low pass filter of cutoff frequency 15 MHz) is V_N [Vrms], $E_N = \frac{V_N}{AV} \cdot \sqrt{15 \times 10^6}$ Test point : V_5	0.47	0.6	$\frac{nV}{\sqrt{Hz}}$
10	Common mode rejection ration	CMRR	b	a	a	a	a	a	a	b	a	a	a	b	a	a	a	In-phase input voltage SG2 : 100 mVp-p, 20 MHz When the Read amplifier output is V_{CM} [mVp-p], $CMRR = 20 \log \frac{100}{V_{CM}}$ +20 log A_V Test point : V_4	50		dB
11	Power supply rejection ratio	PSRR	a	a	a	a	a	a	a	a	a	a	a	b	a	a	a	Ripple voltage SG3 : 100 mVp-p, 20 MHz When the Read amplifier output is V_P [mVp-p], $PSRR = 20 \log \frac{100}{V_P}$ +20 log A_V Test point : V_4	50		dB

No.	Item	Symbol	SW conditions														Measurement conditions	Min.	Typ.	Max.	Unit
			1	2	3	4	5	6	7	8	9	10	11	12	13	14					
12	Channel separation	CS	a	b	a	a	a	c	b	a	a	a	a	b	a	a	50				dB
13	Read data output offset voltage for Read RDX, RDY common mode output voltage difference between modes	V _{OFFR}	a	a	a	a	a	e	b	a	a	a	a	a	b	a	-250		250		mV
14		V _{diff}	a	a	a	a	a	e	b	a	a	a	b	c	a		-300		300		mV
15	RDX, RDY common mode output voltage for Read	V _{RD}	a	a	a	a	e	b	a	a	a	a	a	b	a		V _{CC} -2.6	V _{CC} -2.3	V _{CC} -2.0		V

Unless otherwise specified, $V_{CC}=5$ V, $T_a=25$ °C, f_{WD} (Write data frequency) =5 MHz, $I_w=15$ mA, L_H (Head inductance) =1 μ H, R_H (Head DC resistance value) =30 Ω

Refer to Fig. 2 to Fig. 4

No.	Item	Symbol	Measurement conditions	Min.	Typ.	Max.	Unit
14	Head differential voltage amplitude	V_{SW}	Differential voltage between HX pin and HY pin at switching of Write current		9		Vp-p
15-1	Mode switching time Read to Write	T_{RW}	T_{RW} is the time required for Write current to turn to 90 % after Pin 19 changes from "High" to "Low".		130	150	ns
15-2	Mode switching time Write to Read	T_{WR1}	T_{WR1} is the time required for the Read amplifier output* to turn to 90 % after Pin 19 changes from "Low" to "High".		180	220	ns
		T_{WR2}	T_{WR2} is the time required for Write current to decrease to 10 % after Pin 19 changes from "Low" to "High".		100	200	ns
16	Mode switching time Power saving to Read	T_{IR}	T_{IR} is the time required for the Read amplifier output* to turn to 90 % after Pin 20 changes from "High" to "Low".			1	μ s
17-1	Mode switching time safe to unsafe	T_{SA1}	T_{SA1} is the time required for Pin 11 to turn "High" after the last transition of Write data when Write data is stopped in Write mode.	1.0	2.3	3.0	μ s
17-2	Mode switching time unsafe to safe	T_{SA2}	T_{SA2} is the time required for Pin 11 to turn "Low" after the first transition of Write data in Write mode.			0.6	μ s
18	Head switching time	T_H	T_H is the time required for the Read amplifier output* to reach 90 % when the selected head switched in Read mode.			0.6	μ s
19	Write current propagation delay time	T_{PD}	T_{PD} is the time required for Write current to reach 90 % after the Write data falling edge.		2	7	ns
20-1	Write current rise/fall time	T_R/T_F	T_R is the time required for Write current to reach 90 % from 10 %; T_F is the same time required to reach 10 % from 90 %. $L_H=0$ μ H, $R_H=0$ Ω		1	3	ns
20-2	Write current rise/fall time	T_R/T_F	$L_H=540$ nH, $R_H=25$ Ω , $I_w=10$ mA T_R is the time required for Write current to reach 90 % from 10 %; T_F is the same time required to reach 10 % from 90 %.		3.7		ns

*Read amplifier output 100 mVp-p 10 MHz

Timing Chart 1

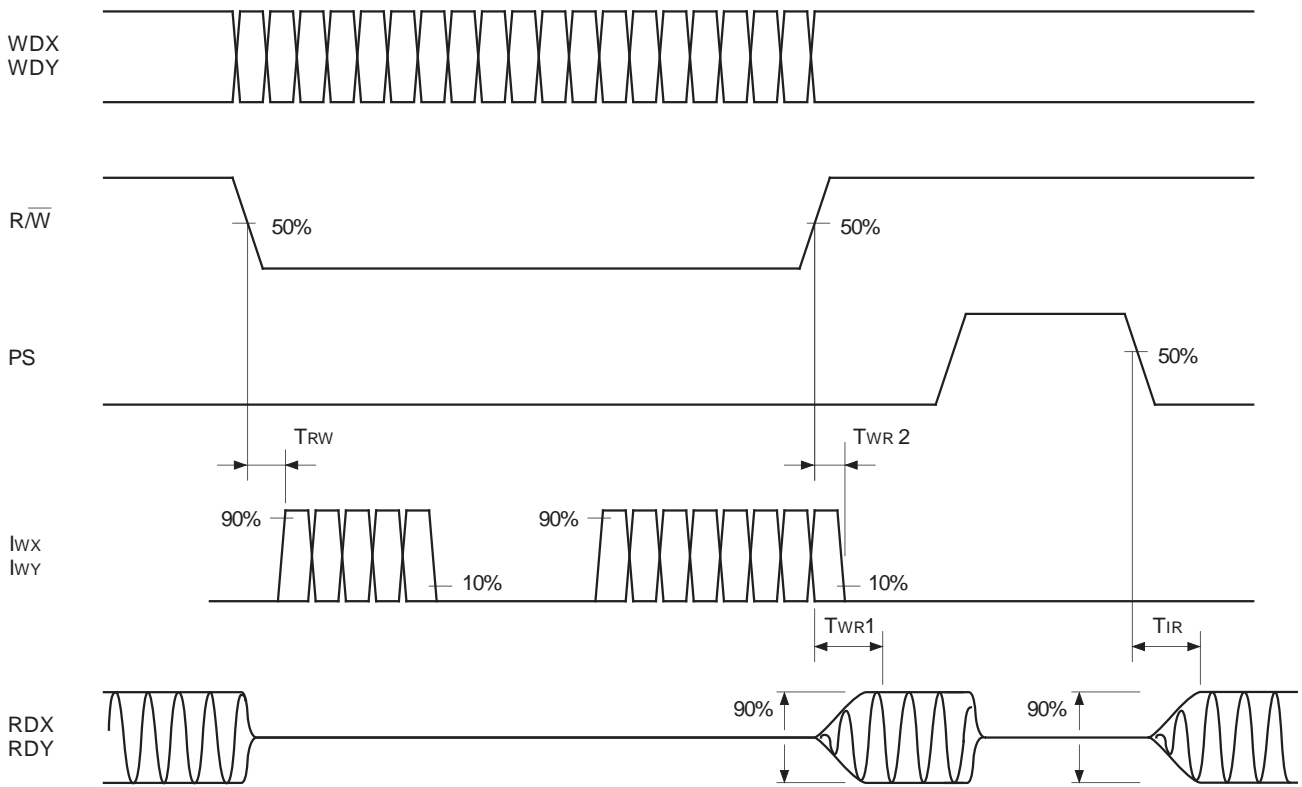

Fig. 3

Timing Chart 2

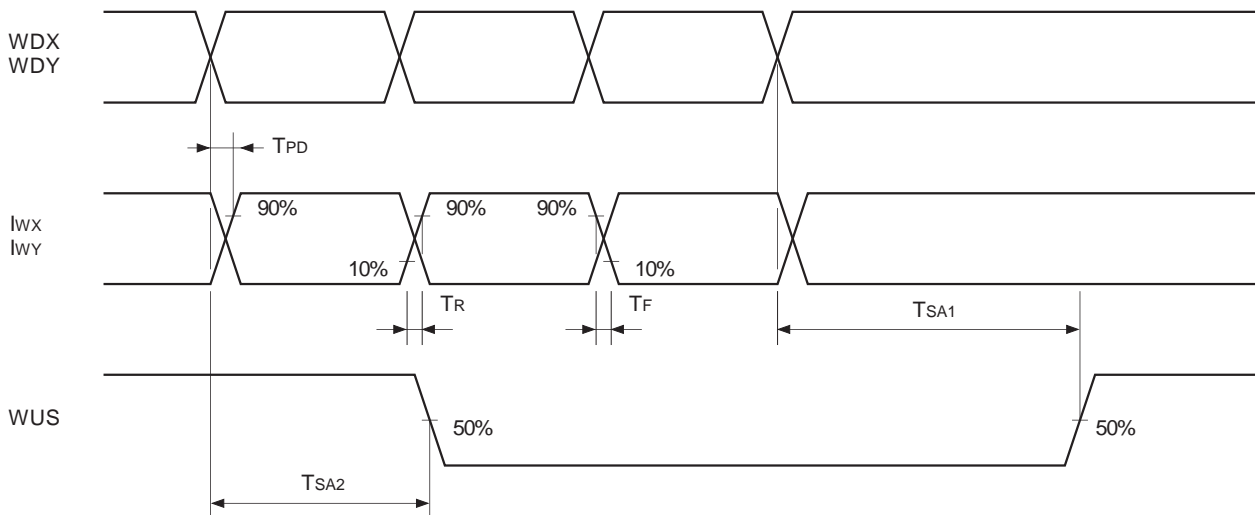

Fig. 4

Description of Functions

Read amplifier

This is a low noise amplifier for amplifying the signals from the heads with an emitter follower output.

The RDX and RDY are the outputs of the differential amplifier whose polarity between the RDX and X side of the head input is same.

Write circuit

The Write data input to WDX pin and WDY pin passes through the buffer amp. It drives the Write switch circuit which supplies the Write current to the heads.

The Write current flows into the X side when WDX is "Low" and WDY is "High".

Mode control

The mode are set as shown Table 1 by XCS, $\overline{R/W}$ and WUS/SE.

XCS	$\overline{R/W}$	WUS/SE	HS0	HS1	Mode
L	L	X	See Table 2		Write
L	H	X			Read
L	L	**	See Table 3		Servo Write
H	X	X	X	X	Power saving

Table 1. Mode selection

Head selection

The heads are selected as shown in Table 2 by the HS0 and HS1 pins.

HS0	HS1	Head
L	L	0
H	L	1
L	H	2
H	H	3

Table 2. Head selection

Servo write mode **

This mode allows for writing to multiple channels at once.

To enable servo write mode follow these steps:

- (1) Place the device in the Read mode.
- (2) Set HS0 and HS1 following Table 3.
- (3) Set WUS/SE to V_{SEH} , or input I_{SEH} to WUS/SE.
- (4) While maintaing step (2) and (3) above make $\overline{R/W}$ low, placing the device in servo write mode.

Write unsafe detection circuit

This circuit detects write errors.

In normal Write mode, the WUS output is low; in the conditions listed below, it is high.

- Head inputs is open (under the condition which. $RH=\infty$ and Write data frequency is ≤ 10 MHz)
- Head input is shorted to GND or V_{CC} .
- Write data frequency is abnormally low.
- No write current.
- In read mode.
- Supply voltage is abnormal (see power supply ON/OFF detection).

Power supply ON/OFF detection

This circuit monitors V_{CC} to detect erroneous Writes. The error status is established when V_{CC} falls below the threshold voltage (V_{TH}) of the power supply ON/OFF detector, in which case the recording and playback functions are prohibited. When V_{CC} rises above, V_{TH} , the prohibition of these functions is released.

HS0	HS1	Head
L	L	0, 1
H	L	0, 1, 2, 3
L	H	2, 3
H	H	0, 1, 2, 3

Table 3. Head selection in Servo Write mode

Application Circuit

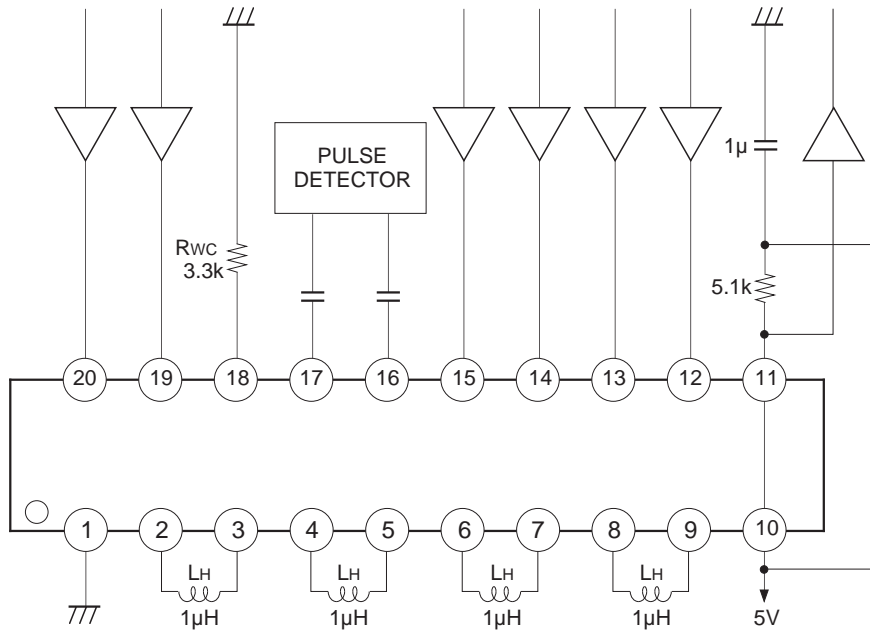

Application circuits shown are typical examples illustrating the operation of the devices. Sony cannot assume responsibility for any problems arising out of the use of these circuits or for any infringement of third party patent and other right due to same.

Notes on operation

- This device handles high frequency and high gain signals. Please note the following;
 - ◆ Connect V_{CC} decoupling capacitor of approximately 1000 pF near the device.
 - ◆ Make the GND area as large as possible.
- When using as 2-channel, short-circuit the X and Y sides of unused head pins or leave them open.
- The WC pin is a constant voltage pin. When noise affects this pin, it creates noise in Write current. Therefore, locate R_{wc} as close to the device as possible.

Write unsafe detection circuit

This circuit uses the voltage waveforms of the head pins for detection.

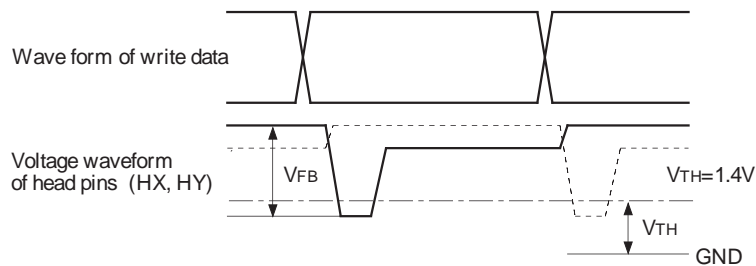

- ◆ V_{FB} must be more than 2 V. When $V_{FB} < 2 V$, it is possible that Write unsafe detection maximum frequency becomes more than 1 MHz.
- ◆ The normal operating area of write unsafe detection circuit is changed by head inductance, head DC resistance, write current and other.

Application Notes

Use the following characteristics for reference.

Vcc=5 V, Ta=25 °C

Item		Symbol	Conditions	Min.	Typ.	Max.	Unit
Write mode	Differential output capacitance	Co	Between head input pins		4.5	6	pF
	Differential output resistance	Ro		260	360	470	Ω
Read mode	Differential input capacitance	CI	Between head input pins		6	10	pF
	Differential input resistance	RI	f=5 MHz	650	1500	3000	Ω
	Output resistance	RRD	RDX or RDY, f=5 MHz			50	Ω
Unselected head differential current in Write mode		IUS	LH=1 μH, RH=30 Ω IW=15 mA			0.2	mAp-p
Write current symmetry		TAS*	LH=0 μH, RH=0 Ω IW=15 mA	-0.5		0.5	ns

*TAS=T1-T2

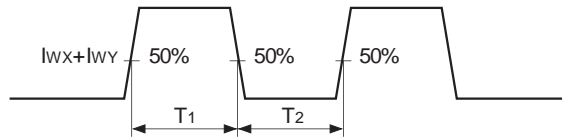

Setting of Write current

Write current can be set with resistor Rwc (kΩ) at Pin 18.

$I_w = K/R_{wc}$ (mA) Refer to Fig. 5.

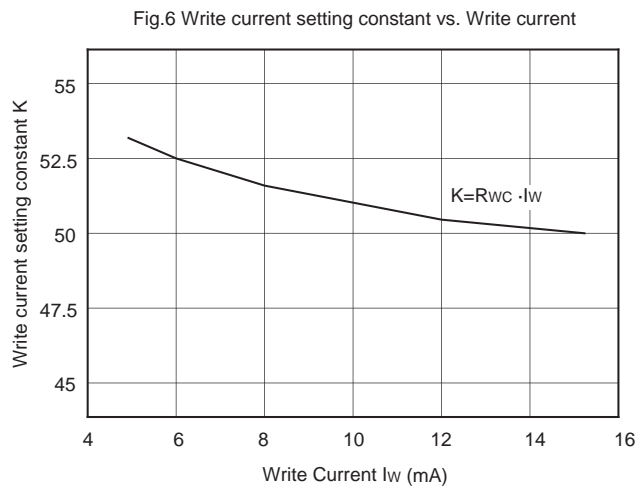
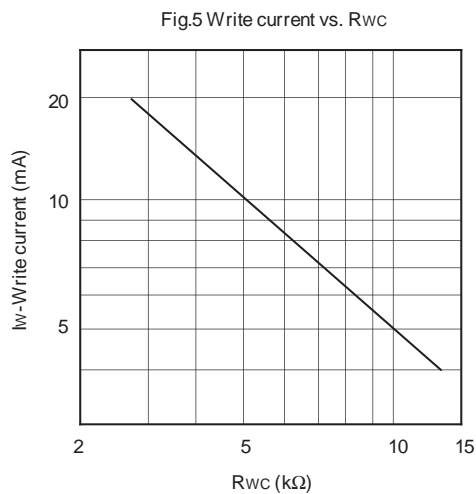
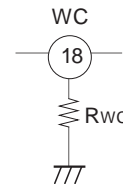

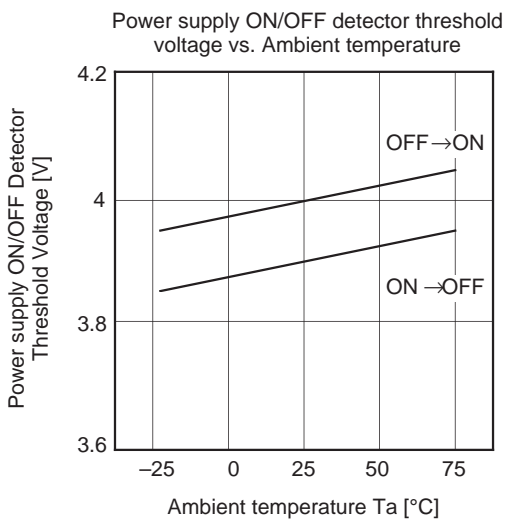
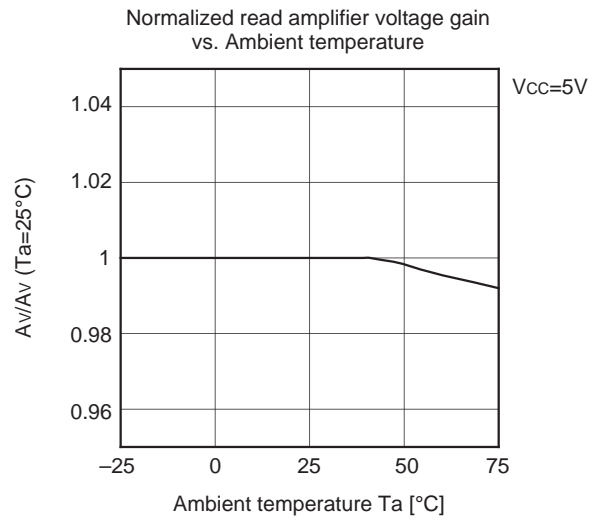
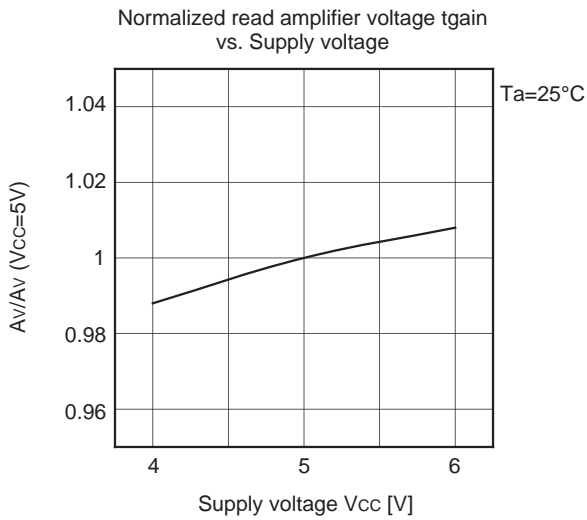
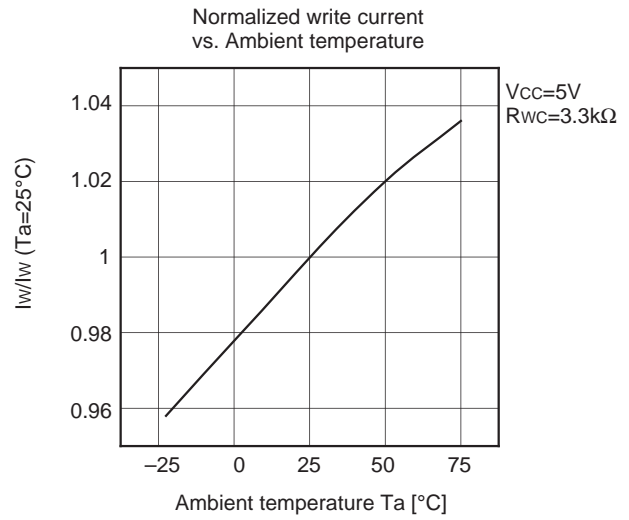
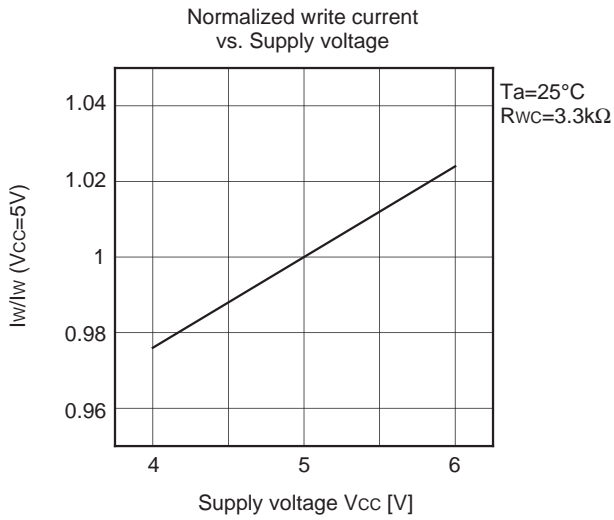

Package Outline Unit : mm

20PIN SSOP (PLASTIC)

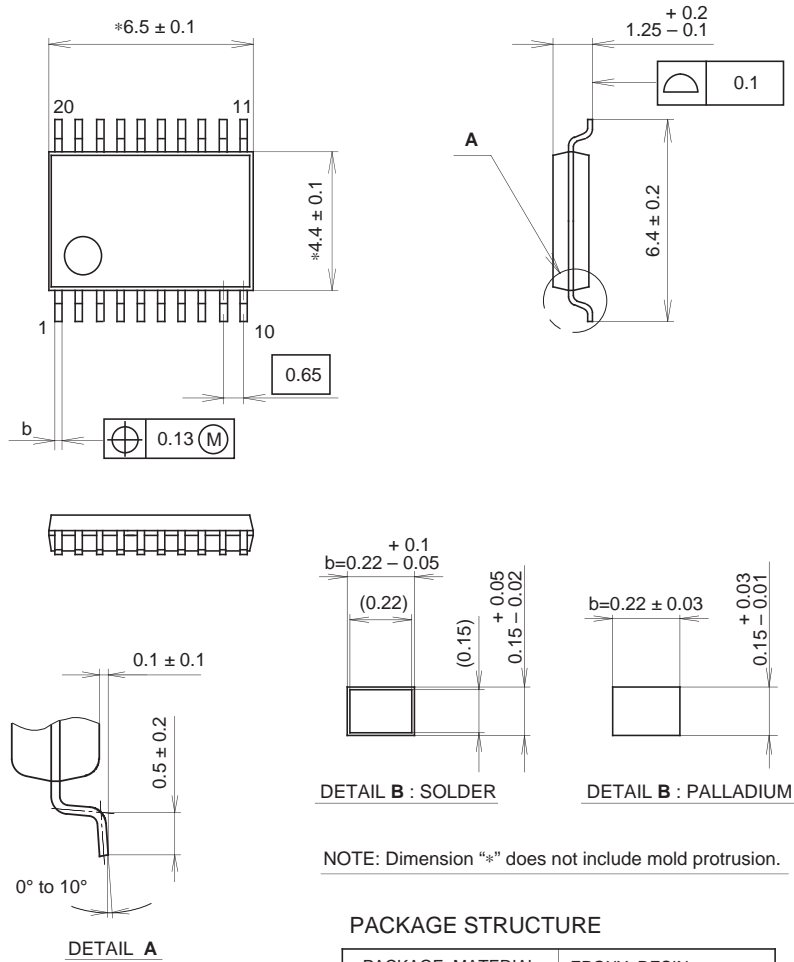

NOTE: Dimension "*" does not include mold protrusion.

PACKAGE STRUCTURE

PACKAGE MATERIAL	EPOXY RESIN
LEAD TREATMENT	SOLDER / PALLADIUM PLATING
LEAD MATERIAL	42/COPPER ALLOY
PACKAGE MASS	0.1g

SONY CODE	SSOP-20P-L01
EIAJ CODE	SSOP020-P-0044
JEDEC CODE	

NOTE : PALLADIUM PLATING
 This product uses PdPPF (Palladium Pre-Plated Lead Frame).